



Halloween Hat Pack

3 - Adult size

Materials you will Need:

- A printed out version of this pattern.
- 1/3 yard polar fleece (you could actually make several from this)
- 1/8 contrasting fleece or felt in multiple colors
- thread
- Rotatry, cutter, ruler mat
- 505 temporary adhesive

You can find the instuctions [here](#).

Please Remember:

- * The free patterns are not for reproduction to be sold in whole or in part.
- * You may not claim these patterns as your own.
- * You may not modify these patterns and claim them as your own
- * You may not use the files or resulting objects from patterns for obscene, defamatory, libelous or immoral works or any other purpose which is prohibited by law.
- * You may not re-post the patterns or tutorials to the web or email them another person - if you want to share them just have them come to www.FleeceFun.com
- * You may however sell completed items you have sewn from the pattern - as long as on the sales tag you credit "Pattern by www.fleecefun.com" and if selling on the internet you must have it in the internet description as "Pattern by www.fleecefun.com". You must also be a sole proprietorship with 3 or less employeess.
- * You may not mass duplicate these patterns (no more than 3 hard copies) without my permission
- * I reserve the right to modify the terms of use at anytime
- * By downloading this pattern you have agreed to these terms.

Fleece Fun
.com

Velvet is pretentious. Fleece is Fun.

Map 2 pieces

Confused on how to assemble the pattern?
No worries!

Just [click here](#) for an easy step by step video to show you how to assemble the pattern.

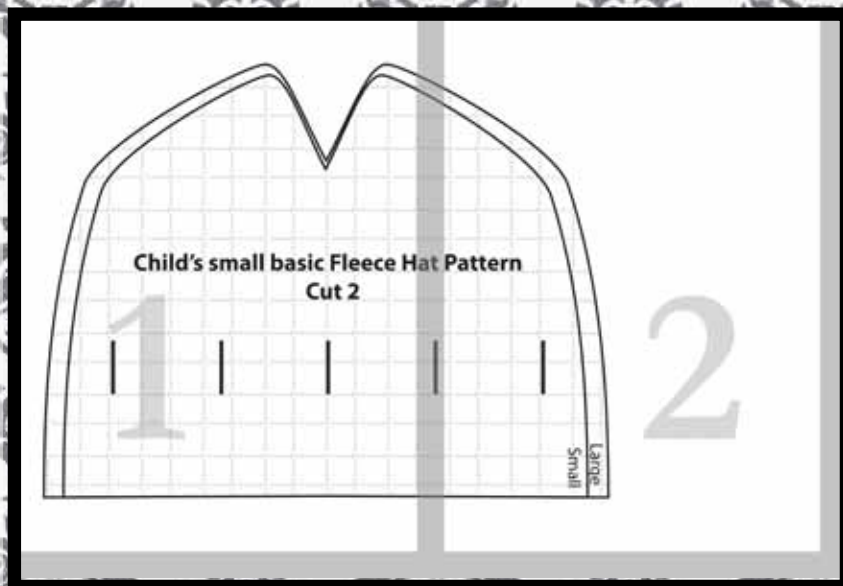

You might also like:





Teen /adult's basic Fleece

Cut 2

Fleece hat Pattern

Small

Medium

Large

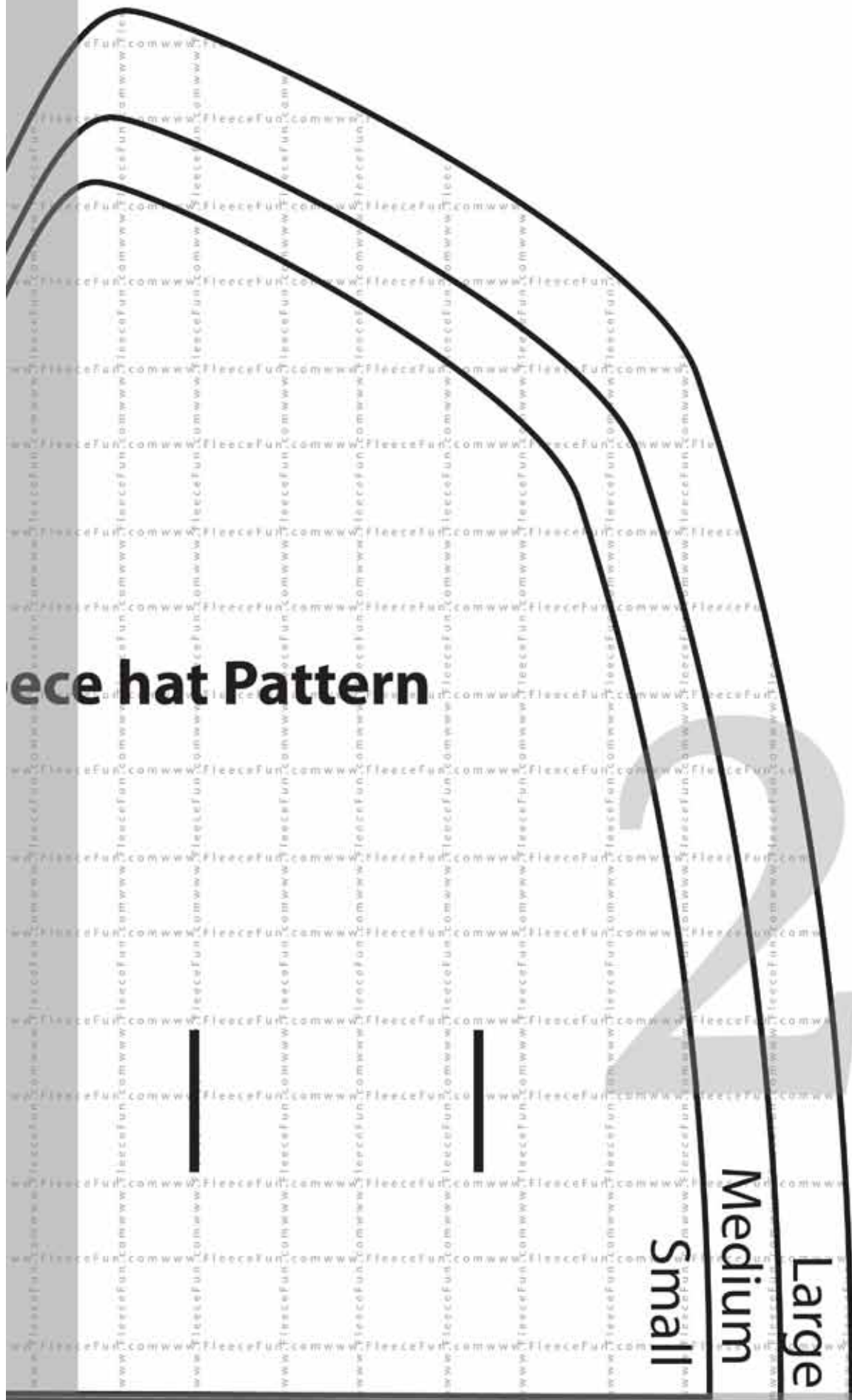

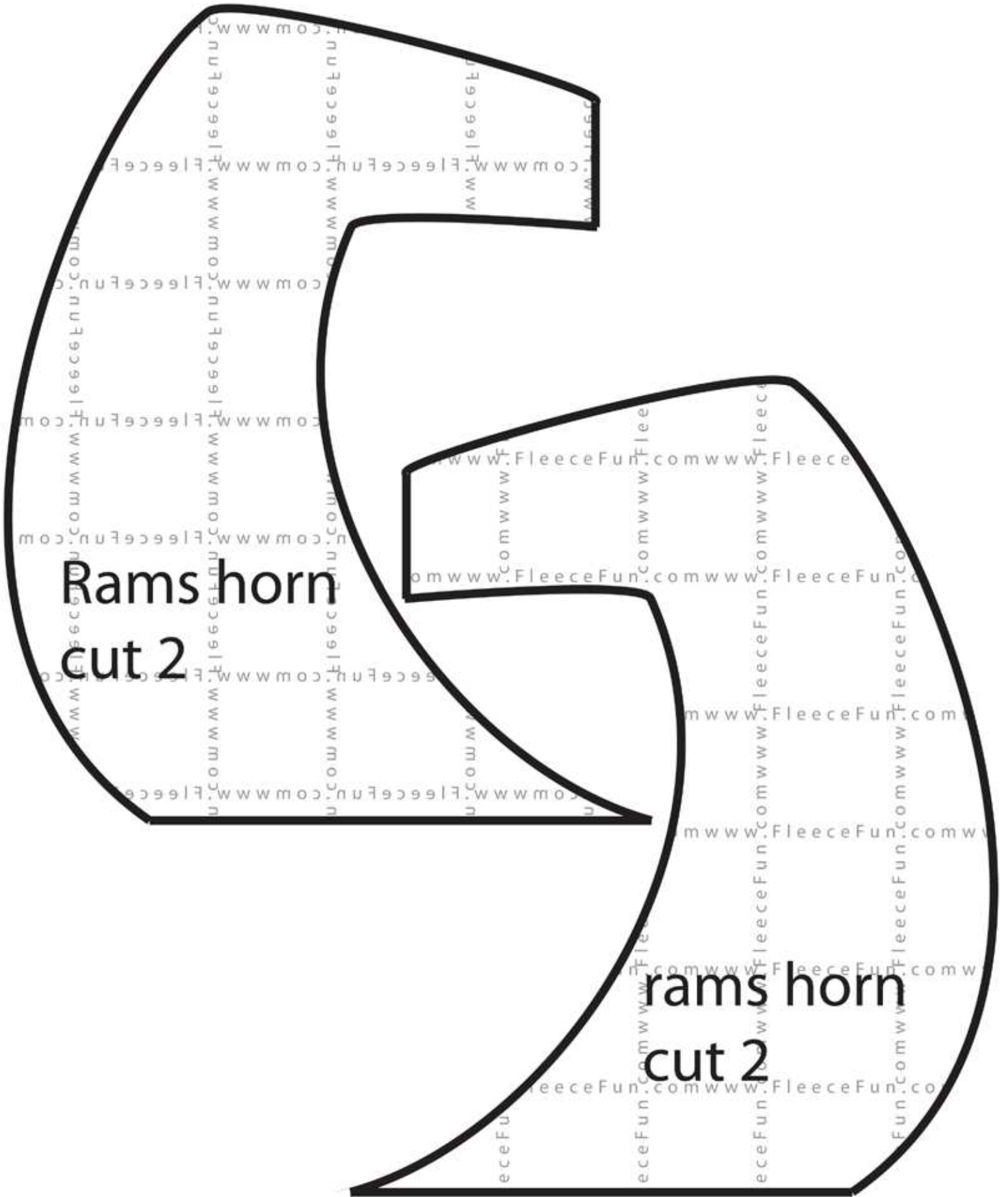

Rams horn
cut 2

rams horn
cut 2

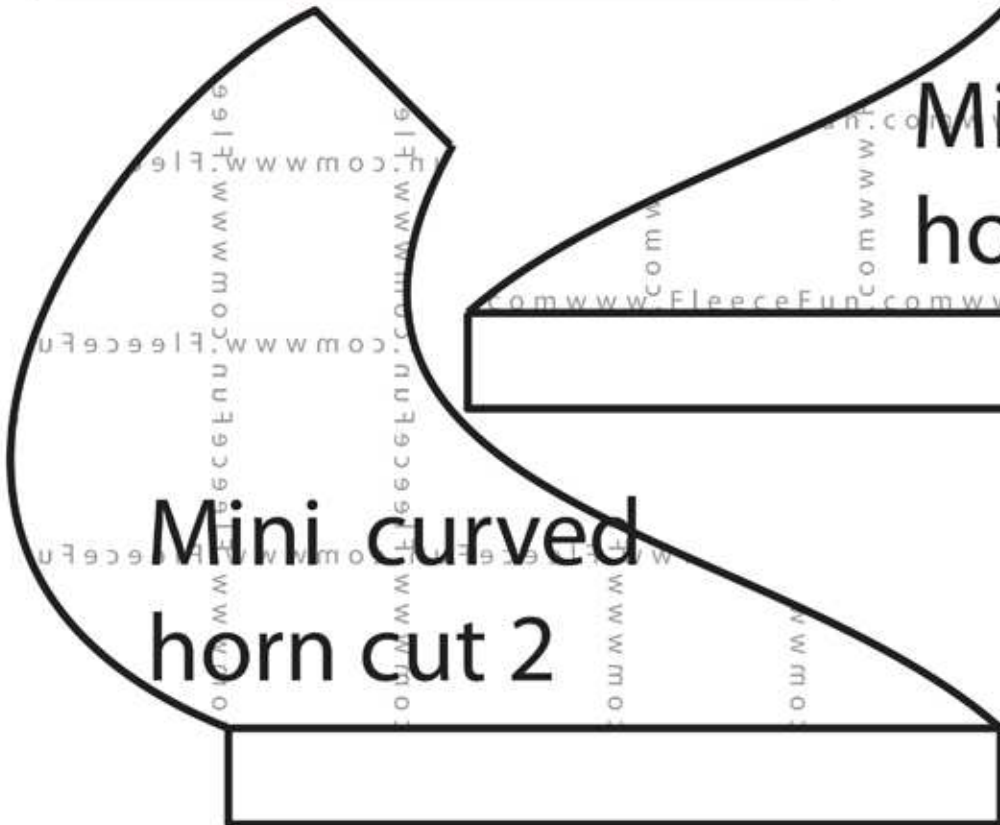
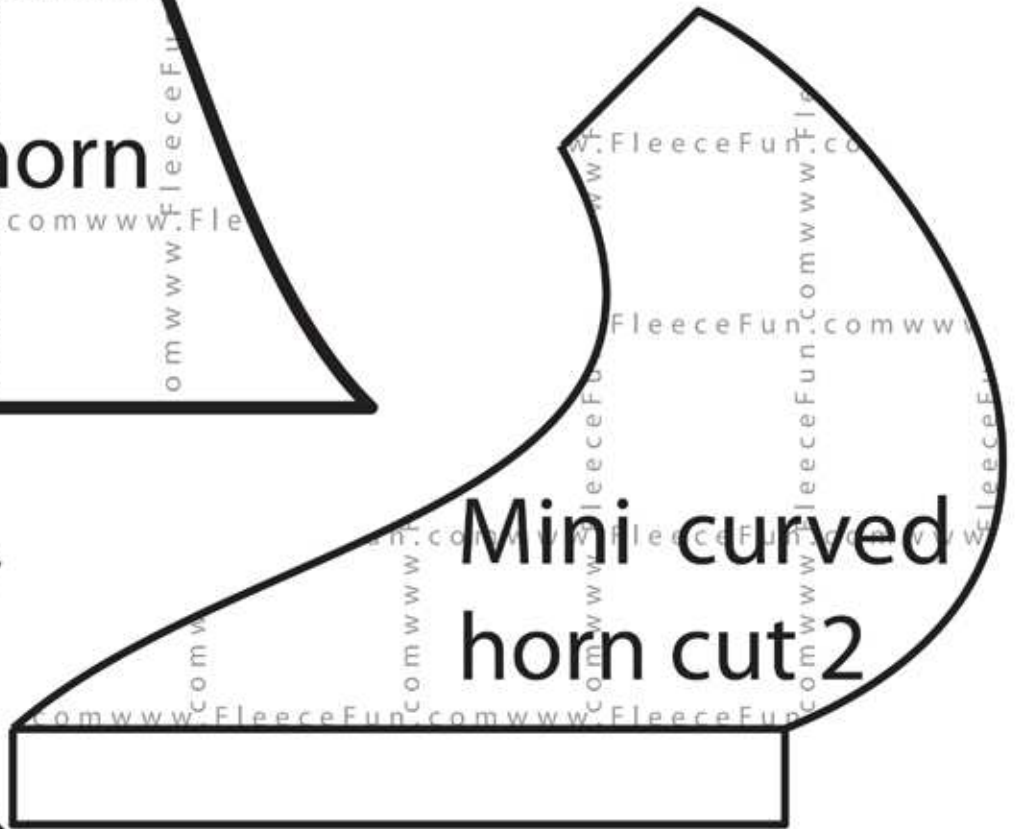

Unicorn horn cut 2

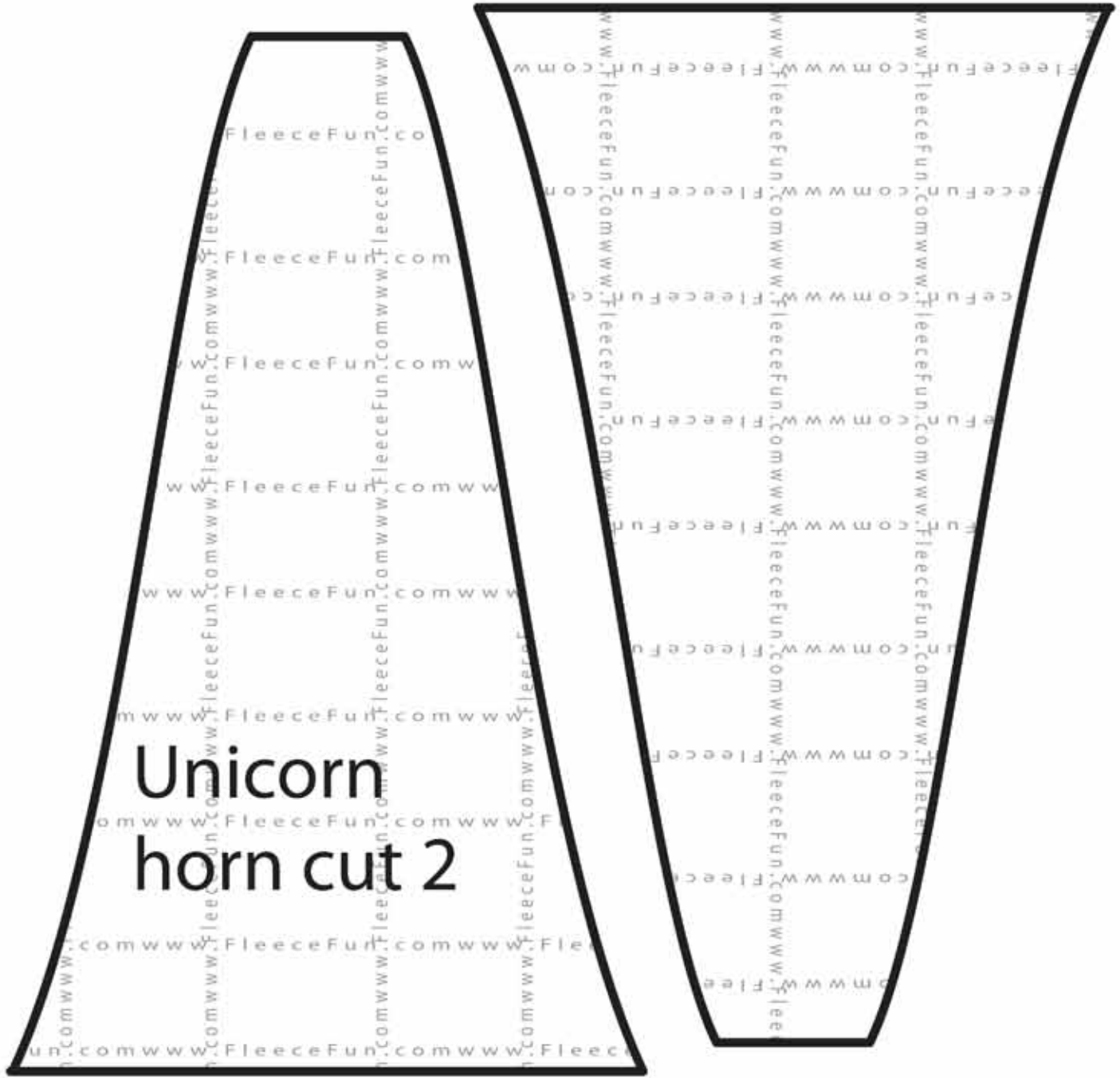

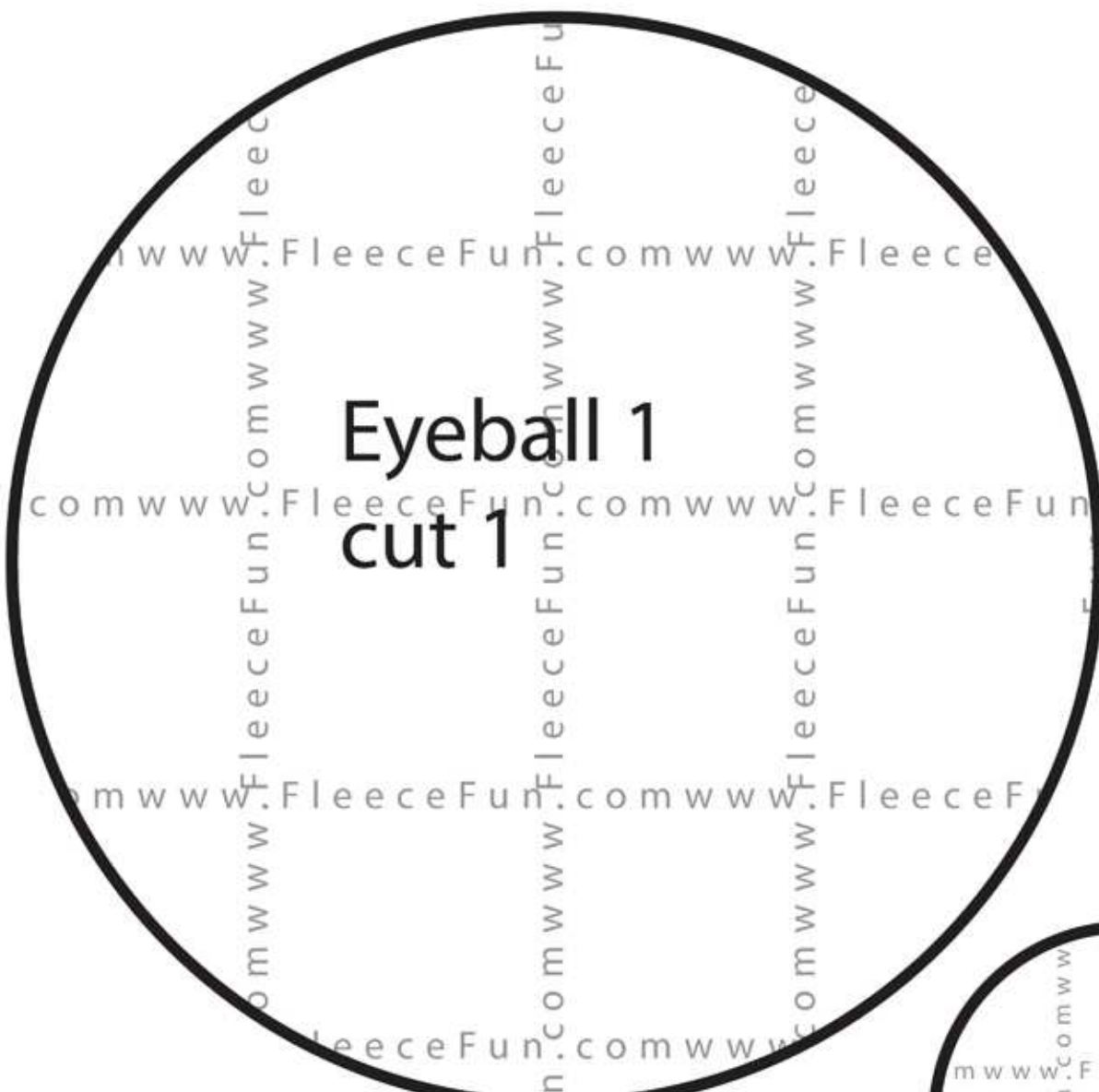

Eyeball 1
cut 1



Pupils

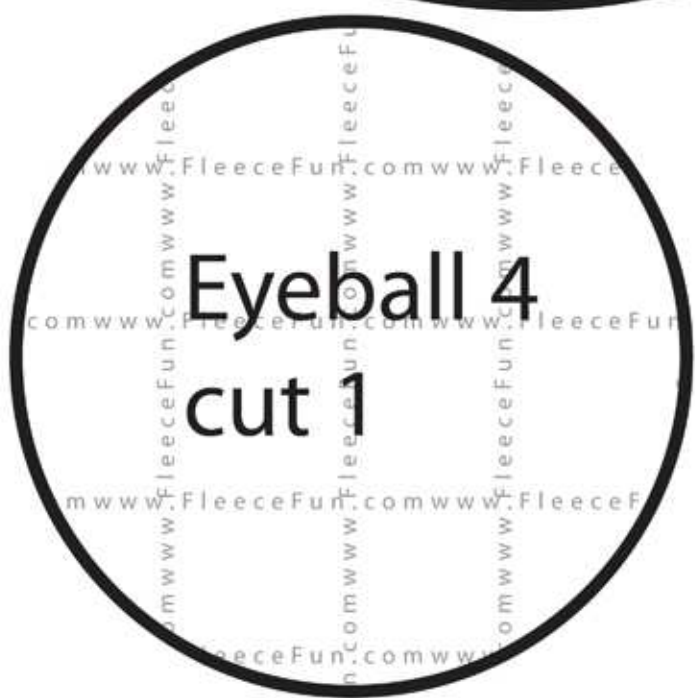

Eyeball 4
cut 1



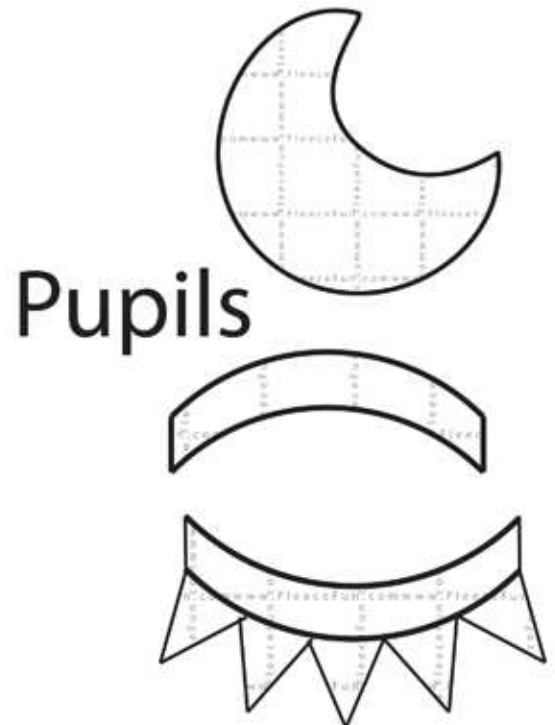
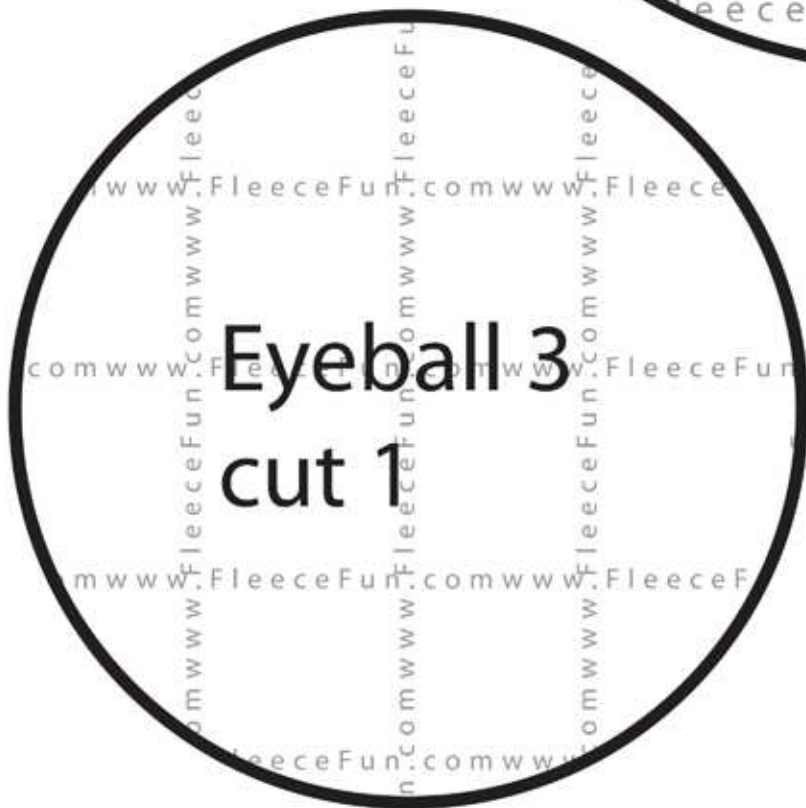
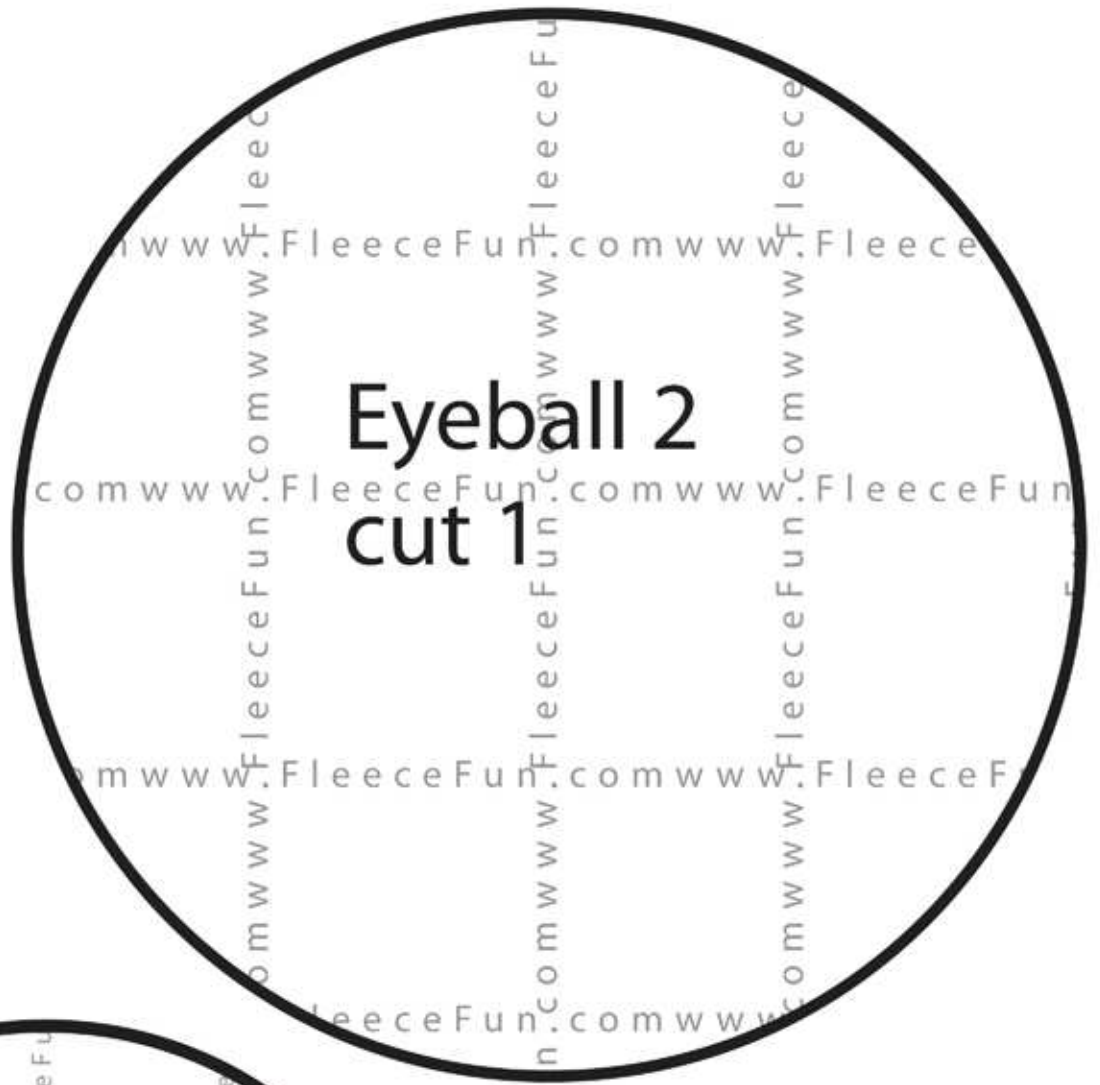

Pupils

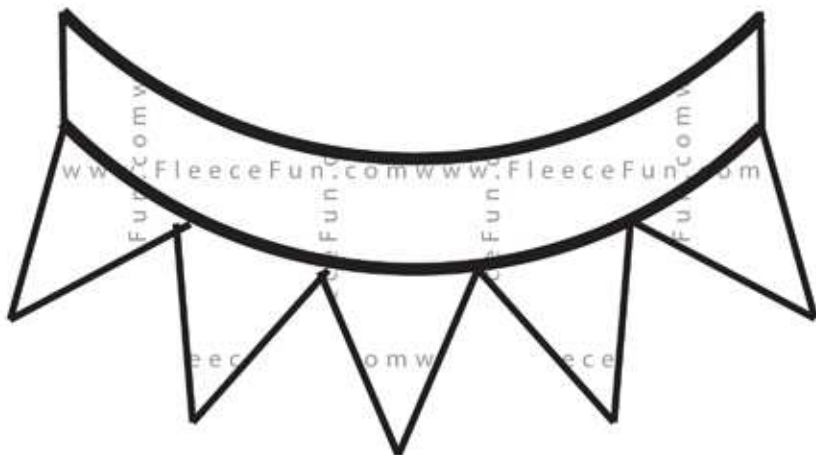
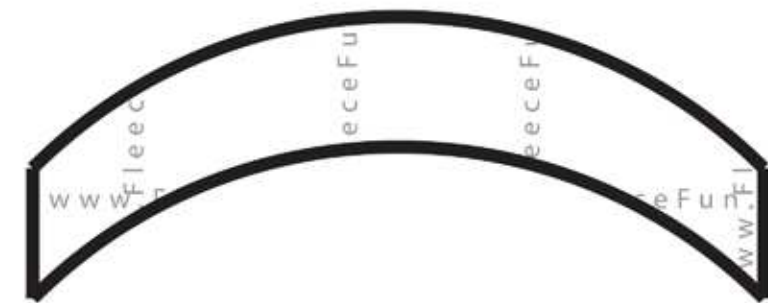
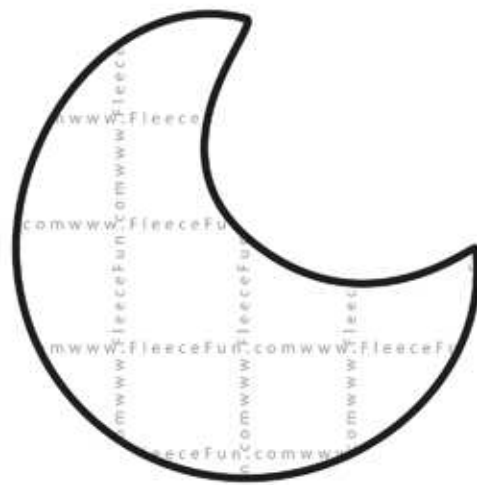
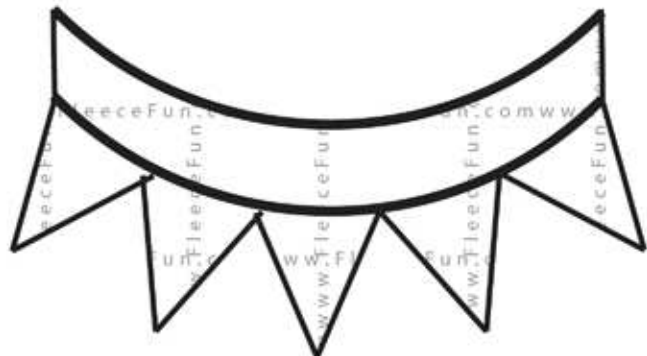
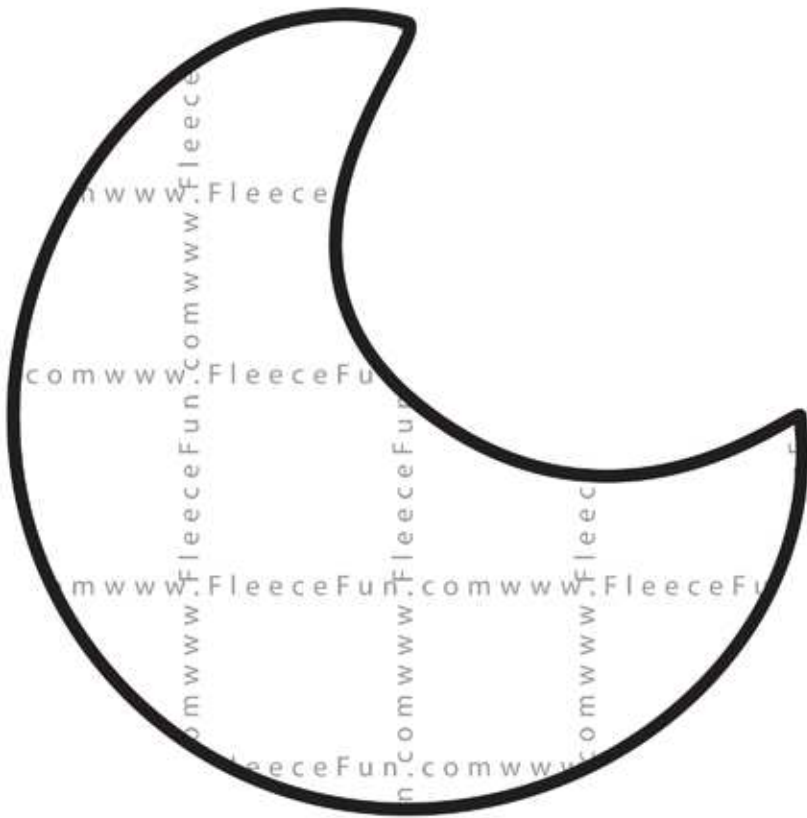

Alien Antenna cut 4

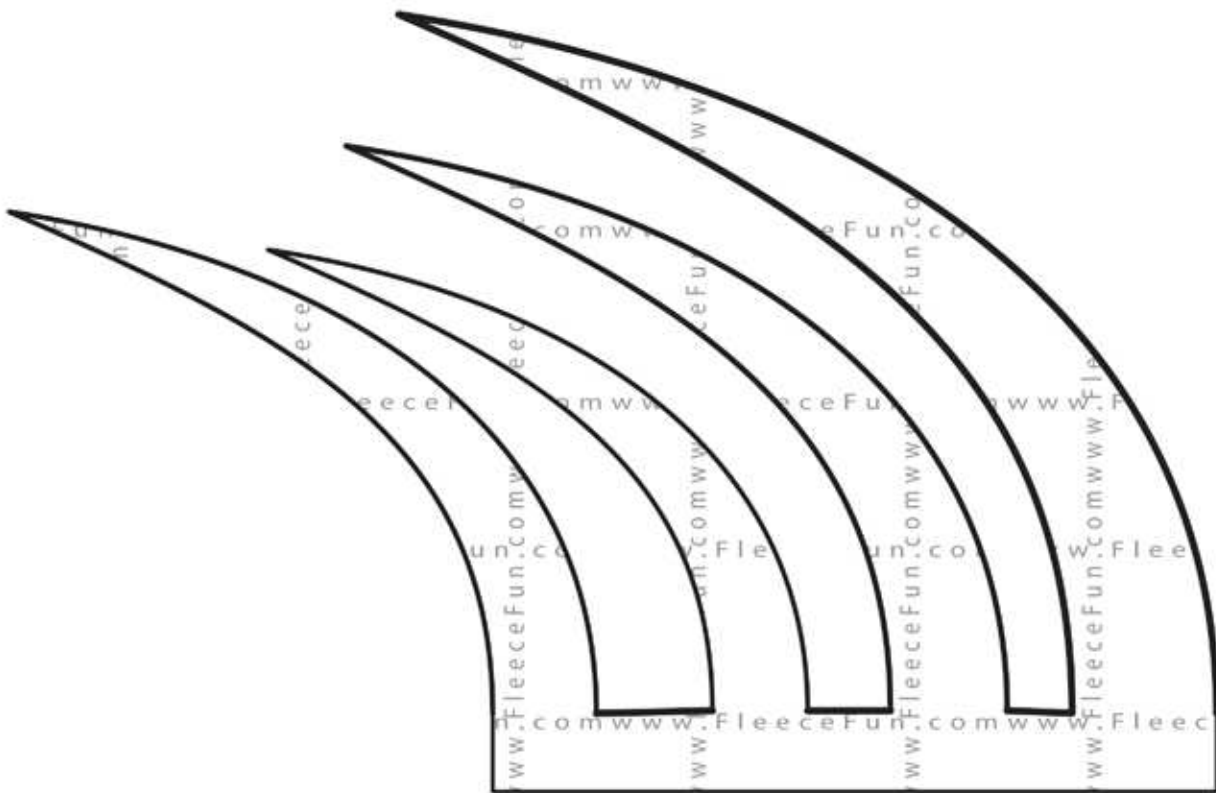
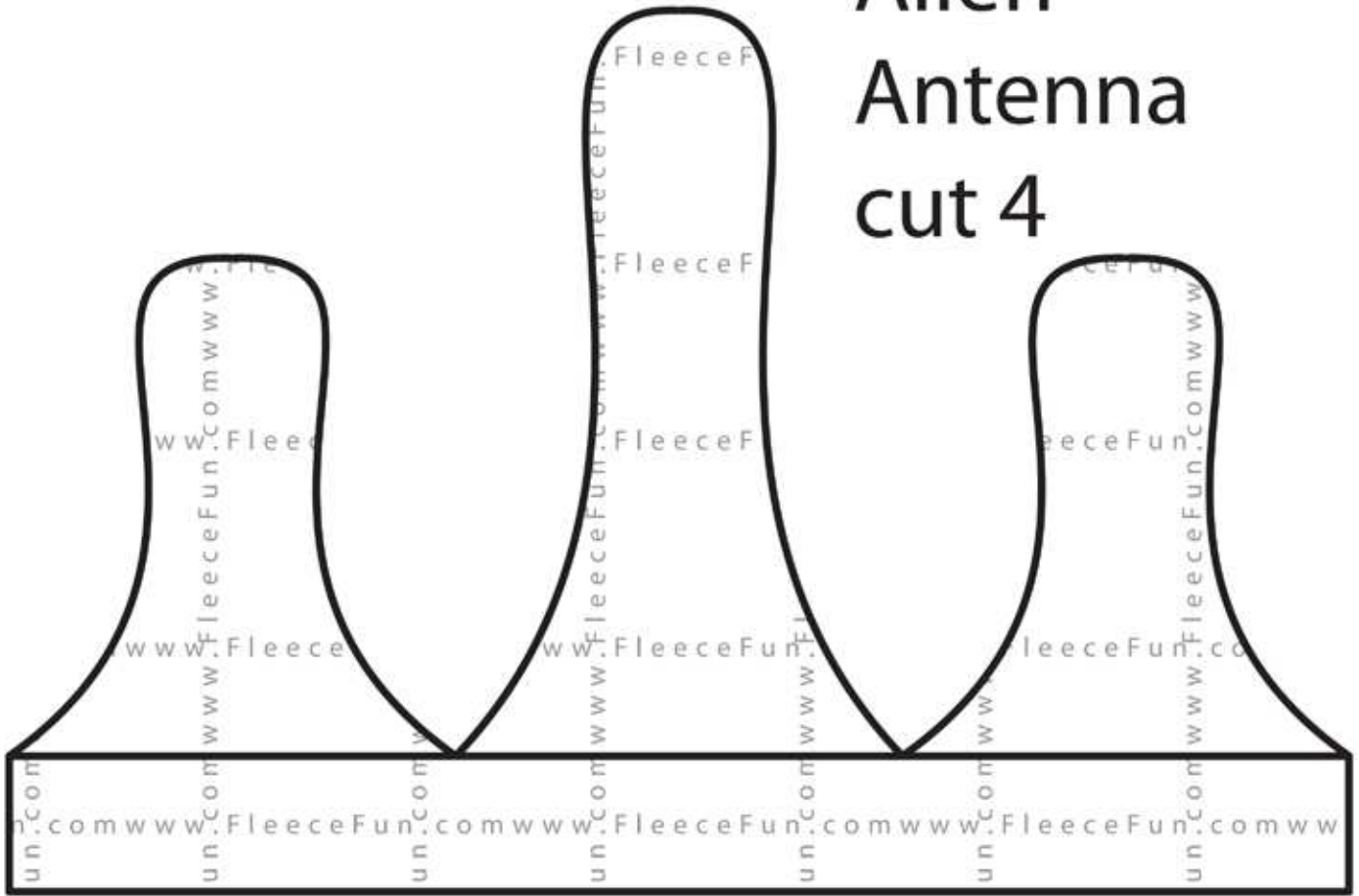

hair cut 2

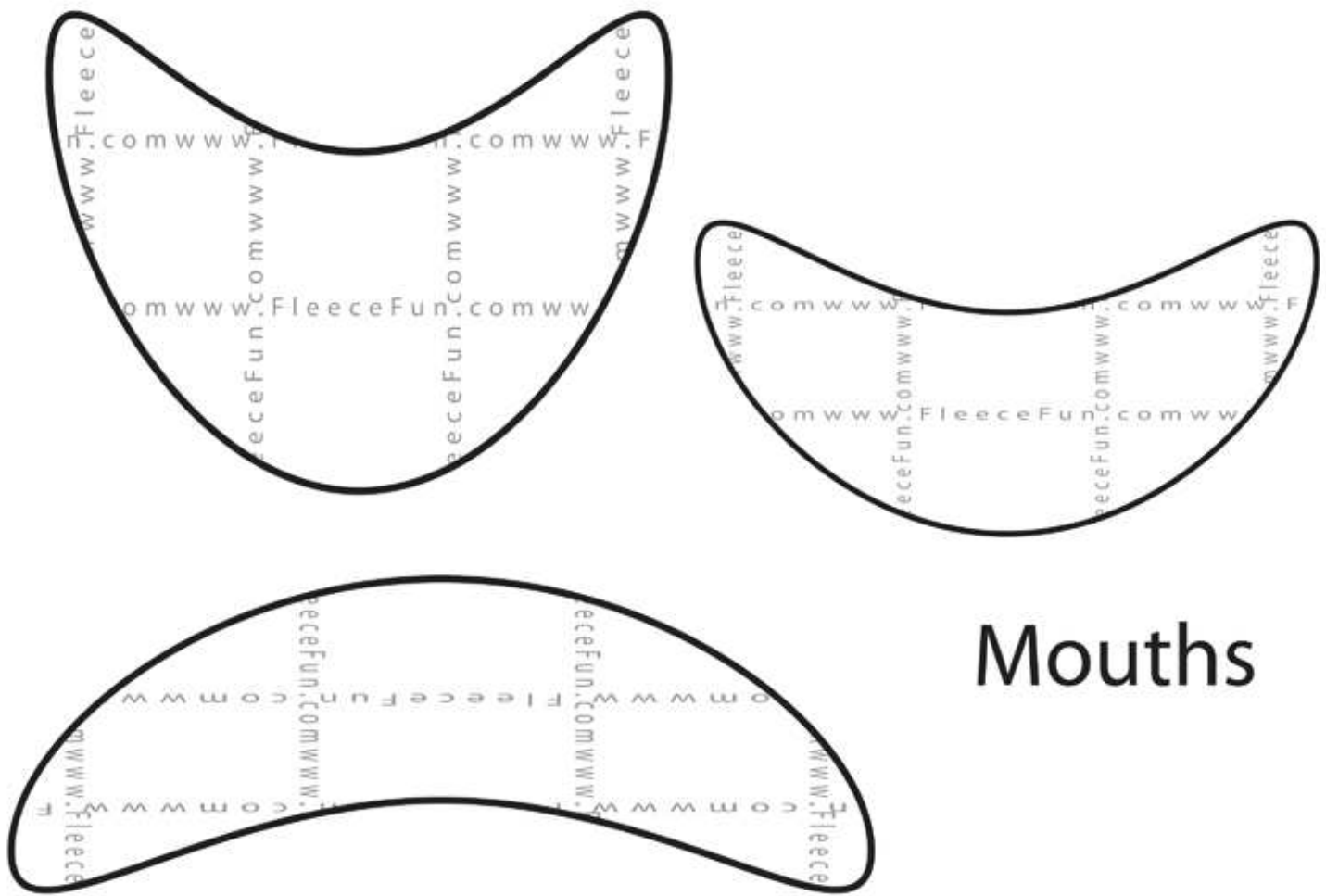

Mouths

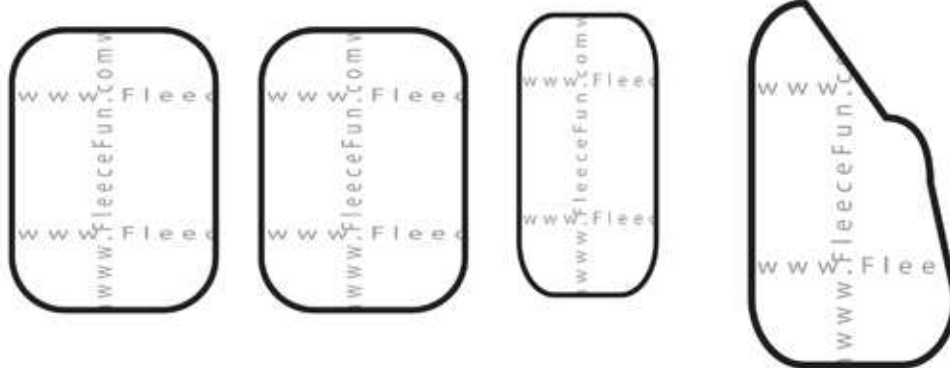

Teeth