



Velvet is pretentious. Fleece is Fun.

# Poke Ball Backpack

by GraciousThreads.ca

Copyright 2016 Fleece Fun All Rights Reserved

## PRINT:

Ensure that the test box measures 1". If not, the sizing of your garment will not be correct. For best results, select no scaling and print from Adobe Reader, not your internet browser.

## ASSEMBLE:

No trim method: overlap the margins so that the black boxes are aligned and tape or glue.

Trim method: trim off the margins using the black boxes as your guide. Butt the edges of the trimmed pattern pieces together and tape.

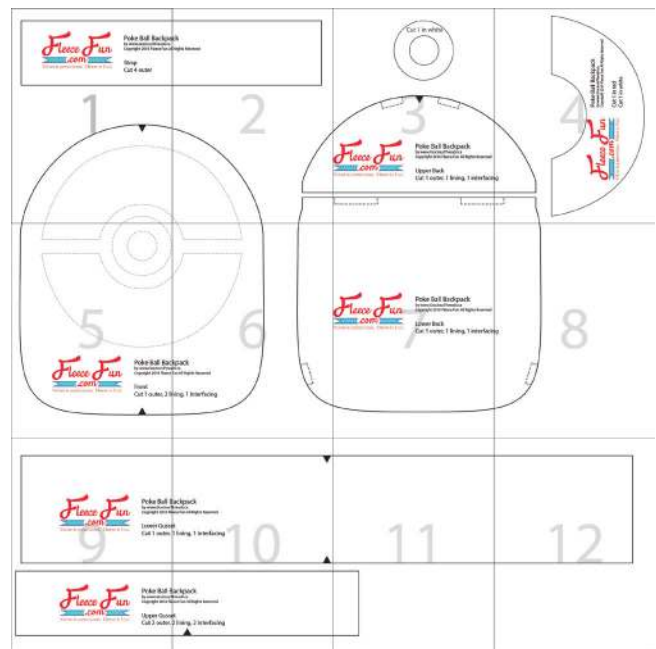

## Please Remember:

- \* The free patterns are not for reproduction to be sold in whole or in part.
- \* You may not claim these patterns as your own.
- \* You may not modify these patterns and claim them as your own
- \* You may not use the files or resulting objects from patterns for obscene, defamatory, libelous or immoral works or any other purpose which is prohibited by law.
- \* You may not re-post the patterns or tutorials to the web or email them another person - if you want to share them just have them come to [www.FleeceFun.com](http://www.FleeceFun.com)
- \* You may however sell completed items you have sewn from the pattern - as long as on the sales tag you credit "Pattern by [www.fleecefun.com](http://www.fleecefun.com)" and if selling on the internet you must have it in the internet description as "Pattern by [www.fleecefun.com](http://www.fleecefun.com)". You must also be a sole proprietorship with 3 or less employees.
- \* You may not mass duplicate these patterns (no more than 3 hard copies) without my permission
- \* I reserve the right to modify the terms of use at anytime
- \* By downloading this pattern you have agreed to these terms.
- \* This pattern is copyrighted - any reproduction of the instructions or pattern without written consent by Angel Peterson is prohibited.



Poke Ball Backpack  
by [www.GraceousThreads.ca](http://www.GraceousThreads.ca)  
Copyright 2016 Fleece Fun All Rights Reserved

Strap  
Cut 4 outer

1

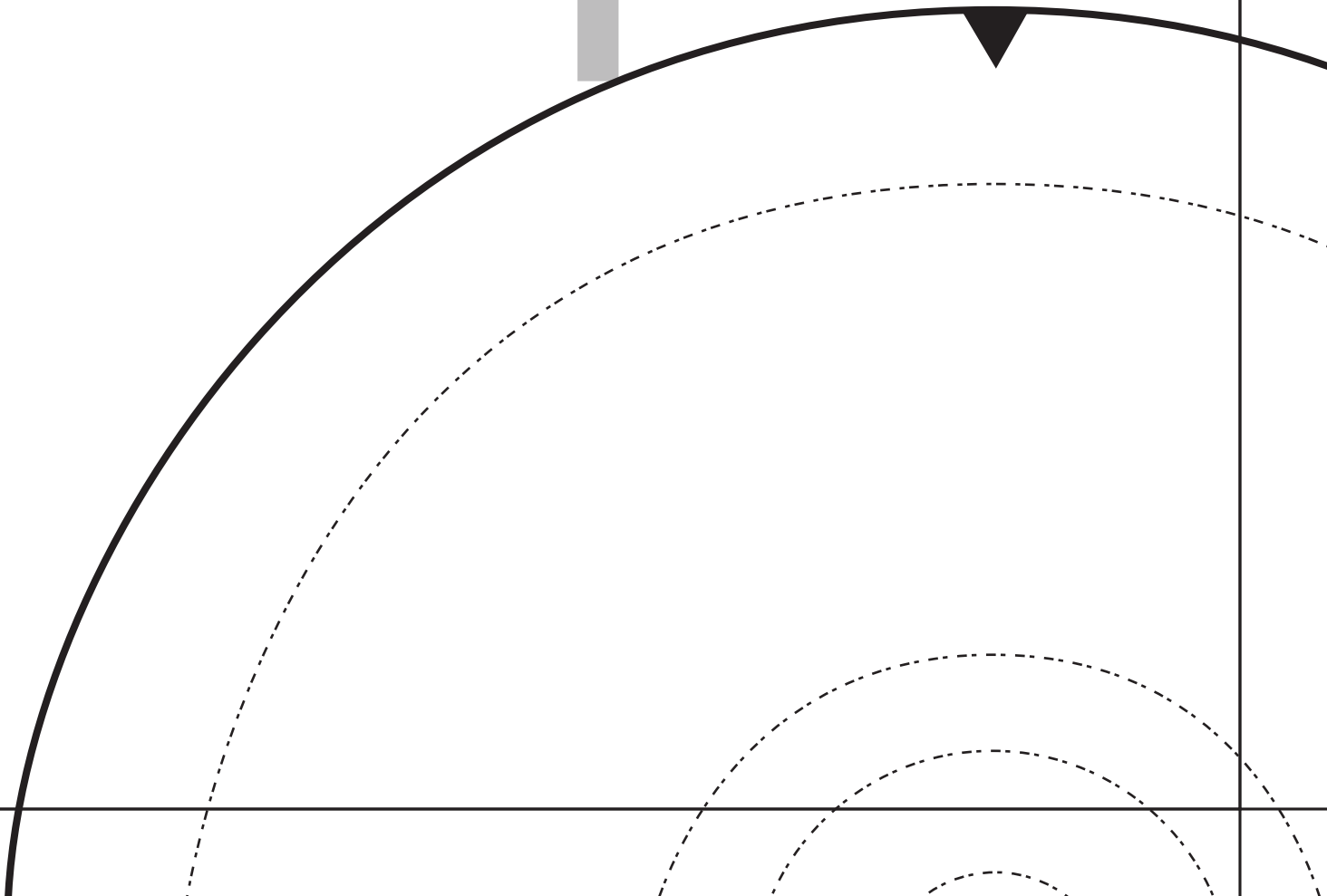

kpack

ds.ca

Fun All Rights Reserved

2



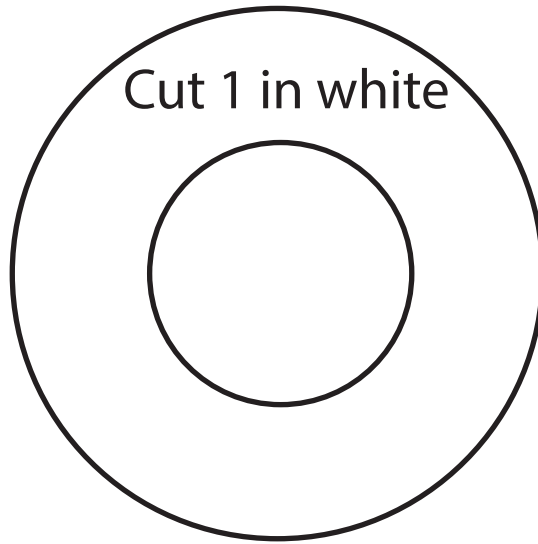

Cut 1 in white



*Fleece Fun*  
*.com*

Velvet is pretentious. Fleece is Fun.

## Poke Ball Backpack

by [www.GraceousThreads.ca](http://www.GraceousThreads.ca)

Copyright 2016 Fleece Fun All Rights Reserved

Upper Back

Cut 1 outer, 1 lining, 1 interfacing



erved

facing

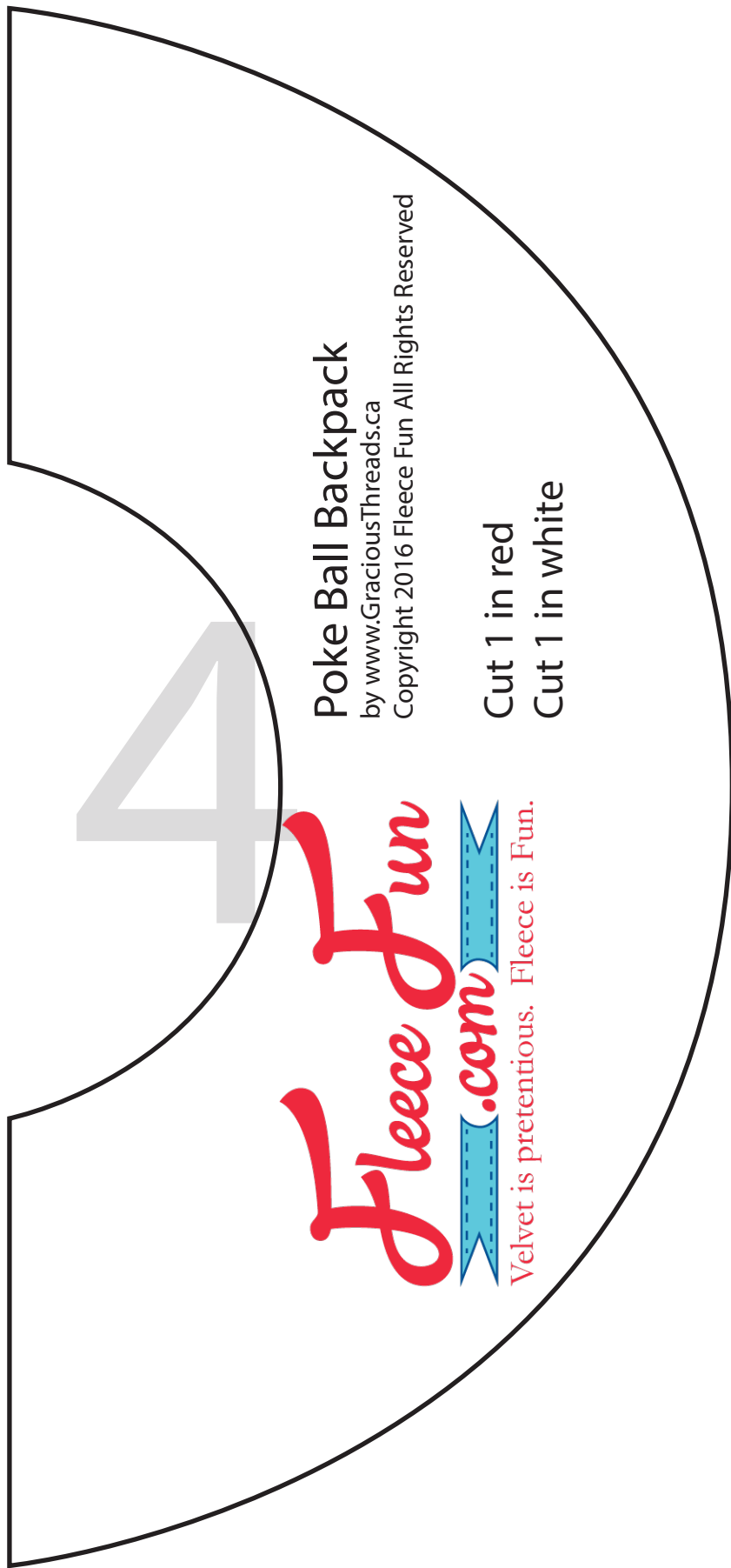

# Poke Ball Backpack

by [www.GraceousThreads.ca](http://www.GraceousThreads.ca)

Copyright 2016 Fleece Fun All Rights Reserved



Cut 1 in red

Cut 1 in white

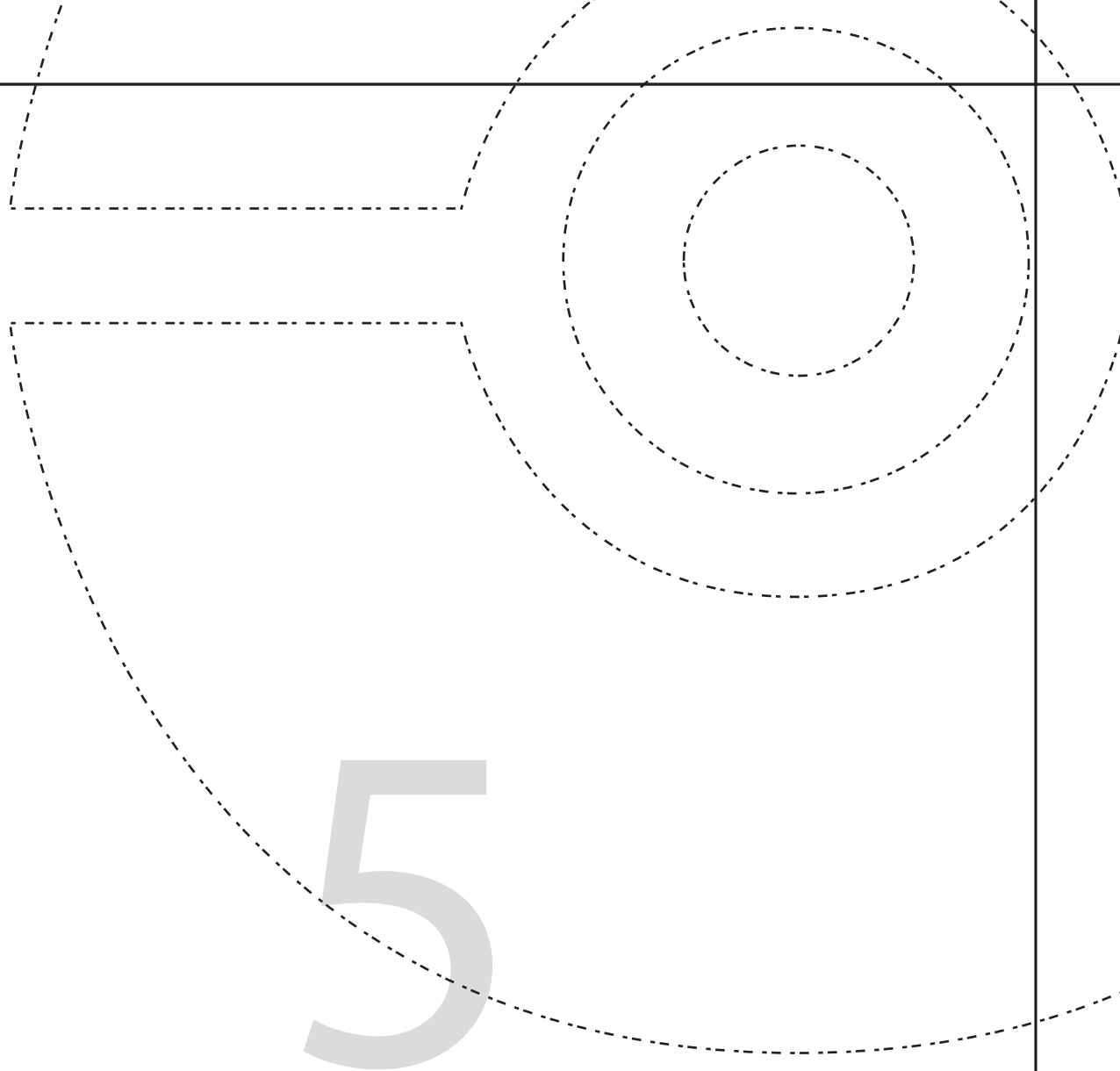

5

*Fleece Fun*  
*.com*

Velvet is pretentious. Fleece is Fun.

Poke Ball Backpa

by [www.GraceousThreads.ca](http://www.GraceousThreads.ca)

Copyright 2016 Fleece Fun All

Front

Cut 1 outer, 2 lining



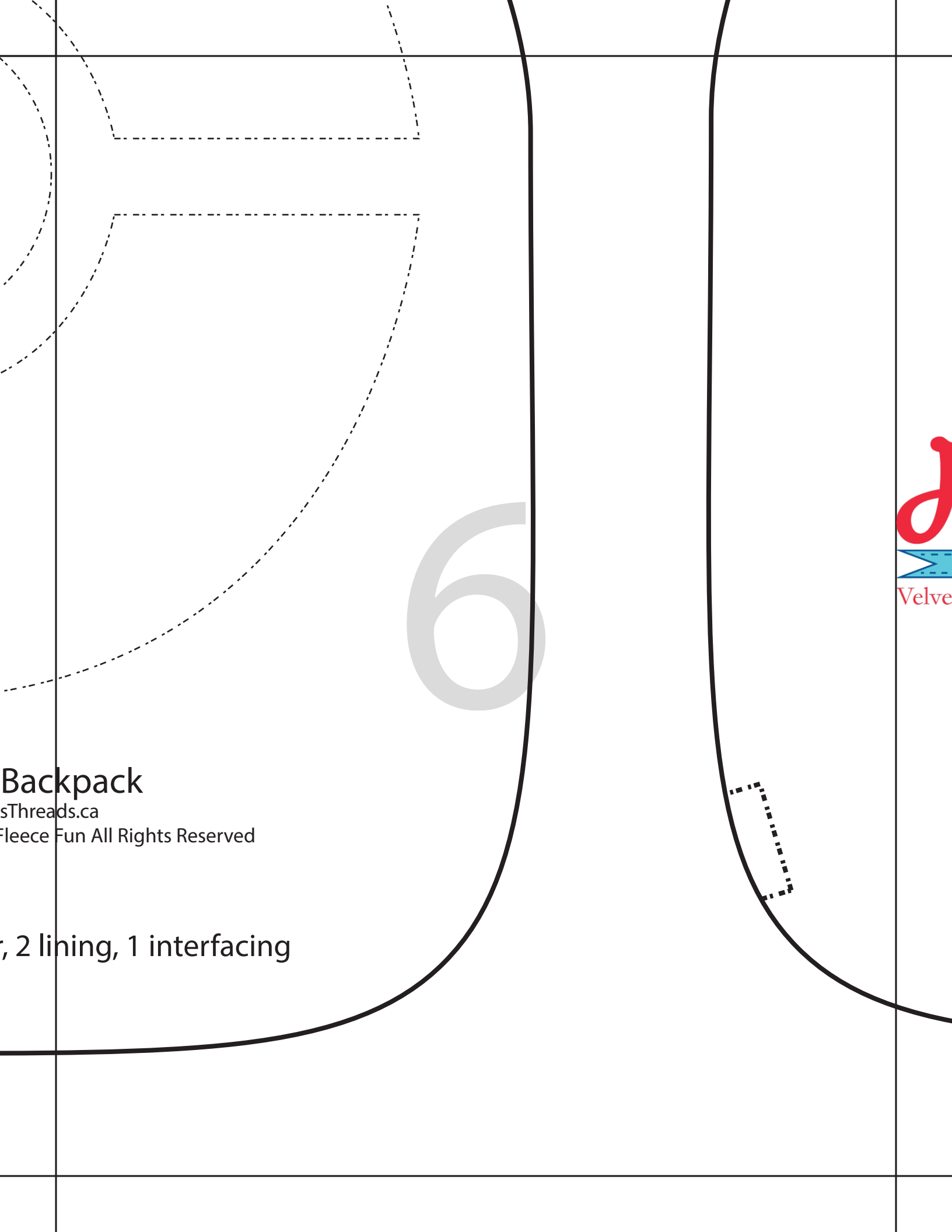

# Backpack

sThreads.ca

Fleece Fun All Rights Reserved

, 2 lining, 1 interfacing





Velvet is pretentious. Fleece is Fun.

## Poke Ball Backpack

by [www.GraciousThreads.ca](http://www.GraciousThreads.ca)

Copyright 2016 Fleece Fun All Rights Reserved

Lower Back

Cut 1 outer, 1 lining, 1 interfacing



erved

facing

8





Poke Ball Back  
by www.GraceousThreads  
Copyright 2016 Fleece Fu

Lower Gusset  
Cut 1 outer, 1 lin



Poke Ball Back  
by www.GraceousThreads  
Copyright 2016 Fleece Fu

Upper Gusset  
Cut 2 outer, 2 lin

# Small Backpack

www.CreationsByCiousThreads.ca

© 2016 Fleece Fun All Rights Reserved

Gusset

Outer, 1 lining, 1 interfacing

10

# Small Backpack

www.CreationsByCiousThreads.ca

© 2016 Fleece Fun All Rights Reserved

Gusset

Outer, 2 lining, 2 interfacing



11

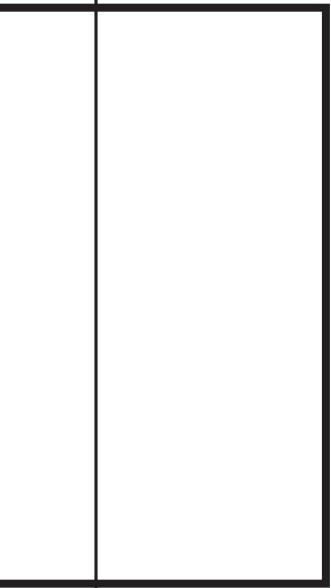

12